

Clarke®

POWER



2.2KW INVERTER GENERATOR

MODEL NO: IG2200

PART NO: 8877055

OPERATION & MAINTENANCE INSTRUCTIONS



LS0510

INTRODUCTION

Thank you for purchasing this CLARKE 2.2kW Inverter Generator

Before attempting to use this product, please read this manual thoroughly and follow the instructions carefully. In doing so you will ensure the safety of yourself and that of others around you, and you can look forward to your purchase giving you long and satisfactory service.

GUARANTEE

This product is guaranteed against faulty manufacture for a period of 12 months from the date of purchase. Please keep your receipt which will be required as proof of purchase.

This guarantee is invalid if the product is found to have been abused or tampered with in any way, or not used for the purpose for which it was intended.

Faulty goods should be returned to their place of purchase, no product can be returned to us without prior permission.

This guarantee does not effect your statutory rights.

ENVIRONMENTAL PROTECTION

One of the most damaging sources of pollution is oil. Do not throw away used engine oil in with your domestic trash or down drains and sinks. Place it in a leak proof container and dispose of it according to local regulations.

TABLE OF CONTENTS

| | |
|--|-----------|
| INTRODUCTION | 2 |
| GUARANTEE | 2 |
| ENVIRONMENTAL PROTECTION | 2 |
| TABLE OF CONTENTS | 3 |
| GENERAL SAFETY RULES | 4 |
| Work area | 4 |
| Positioning the generator | 4 |
| Fire prevention | 4 |
| Prevention of electric shock | 5 |
| Additional safety rules for generators | 5 |
| SAFETY SYMBOLS | 6 |
| GENERATOR OVERVIEW | 7 |
| UNPACKING AND ASSEMBLY | 8 |
| BEFORE USING THE GENERATOR | 8 |
| Earth point | 8 |
| Checking the air filter | 9 |
| Check the engine oil level | 10 |
| Check the fuel level | 11 |
| USING YOUR GENERATOR | 12 |
| Starting the engine | 12 |
| Connecting electrical devices | 14 |
| Economy switch | 16 |
| Indicator lights | 16 |
| Shutting down the generator | 17 |
| MAINTENANCE | 18 |
| Engine oil (every 20 hours of use) | 18 |
| Air filter (every 50 hours of use) | 19 |
| Spark plug (every 50 hours of use) | 20 |
| Fuel tank filter | 21 |
| TROUBLESHOOTING | 22 |
| PARTS AND SERVICING | 22 |
| SPECIFICATIONS | 23 |
| DECLARATION OF CONFORMITY | 24 |
| NOTES | 26 |

GENERAL SAFETY RULES



WARNING: EXHAUST FUMES CAN BE EXTREMELY DANGEROUS IF INHALED

WORK AREA

- *Always use in a well ventilated area.*
- *Always position the exhaust outlet away from people.*
- *Read these safety instructions before using the equipment.*
- *Keep children away from the generator*

POSITIONING THE GENERATOR

1. Keep the generator at least 1 m (3 ft) from buildings or other equipment, or the engine may overheat.
2. Place the generator on a solid, flat surface.
3. Make sure the surrounding area is free from any material that could burn or be damaged by heat.
4. **Never** move or tilt the generator whilst it is switched on.

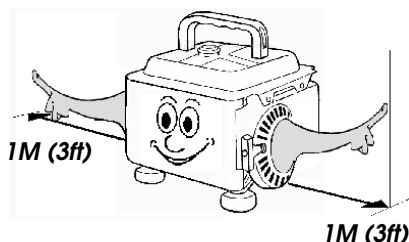

FIRE PREVENTION

1. **Always** switch the engine OFF when refuelling.
2. **Always** refuel in a well ventilated area.
3. **Never** refuel while smoking or in the vicinity of an open flame.
4. **Never** overfill the tank, fill to the level specified (See "Check the fuel level" on page 11.).
5. **Never** smoke whilst refuelling and avoid smoking or using a naked flame near the generator.

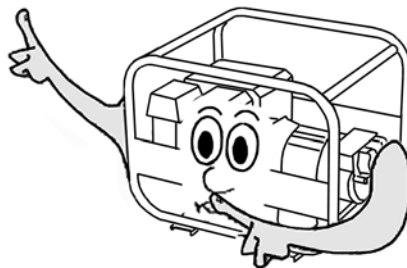

6. **Never** start the engine if there is spilled fuel. Any spillage must be wiped clean and the generator allowed to dry before attempting to start the engine.

PREVENTION OF ELECTRIC SHOCK

1. **Never** use the generator in wet conditions unless it is well protected/ covered. Under these conditions, adequate ventilation **MUST** be provided
2. **Never** operate the generator with wet hands
3. **Never** use water or any other liquids to clean the generator.
4. Make sure you ground (earth) the generator.

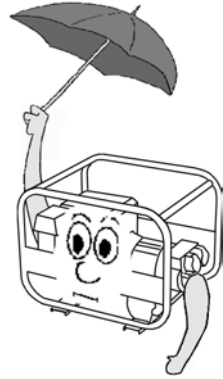

ADDITIONAL SAFETY RULES FOR GENERATORS

1. **Always** make sure the applied load does not exceed the generator rating. Overloading the generator is dangerous and could cause serious damage.
2. **Always** disconnect the generator when carrying out any maintenance.
3. **Always** allow the generator to reach operating speed before connecting a load.
4. **Never** allow the generator to run out of fuel when a load is connected.
5. **Never** transport the generator with fuel in the tank.
6. **Never** connect the generator to a commercial or residential power supply; e.g. ring main.
7. **Never** allow the generator air vents to become blocked.

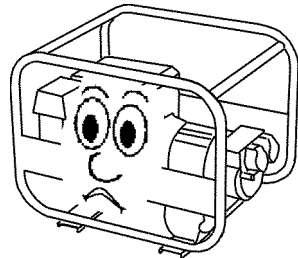
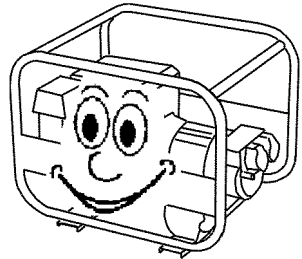

SAFETY SYMBOLS



Caution - The user should be aware of a general hazard



Dangerous Voltage



Flammable



Hot Surface - Do not touch



Poisonous fumes - Do not use the generator in an enclosed space.



Read Instruction manual before use.

GENERATOR OVERVIEW

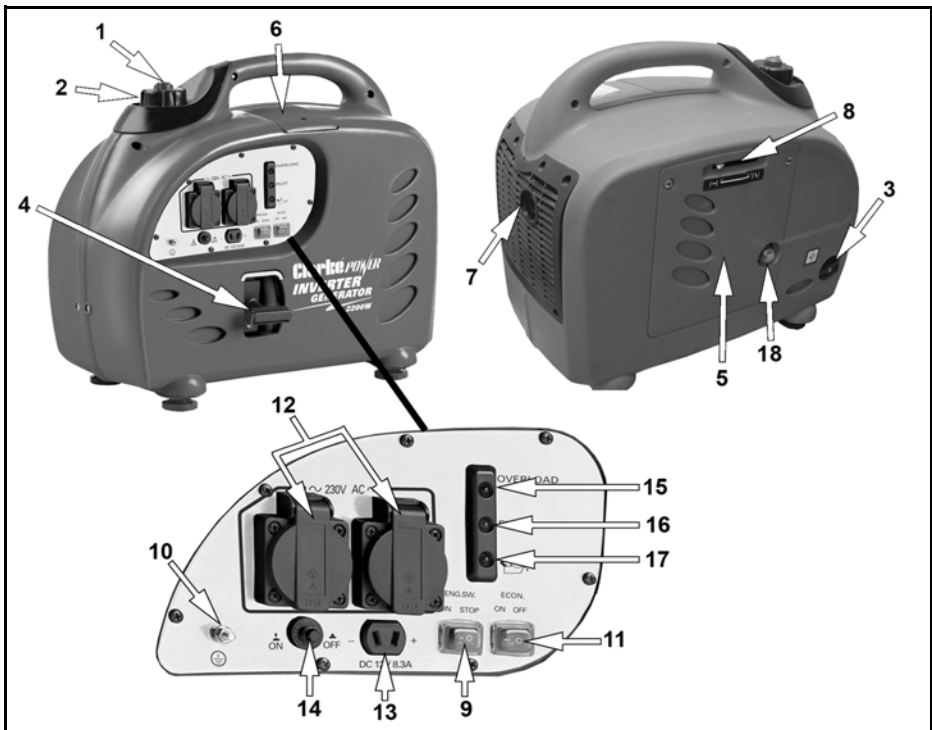

| NO | DESCRIPTION | NO | DESCRIPTION |
|----|-----------------------------|----|------------------------|
| 1 | Air Vent Knob | 10 | Earthing Point |
| 2 | Fuel Cap | 11 | Economy Control Switch |
| 3 | Fuel Valve Knob | 12 | AC Sockets |
| 4 | Starting Handle | 13 | DC Socket |
| 5 | Left Side Maintenance Cover | 14 | DC Circuit Breaker |
| 6 | Top Maintenance Cover | 15 | Overload Indicator |
| 7 | Muffler | 16 | Output Indicator |
| 8 | Choke | 17 | Oil Alarm Indicator |
| 9 | Engine ON/OFF Switch | 18 | Primer Bulb |

UNPACKING AND ASSEMBLY

Unpack your Generator and check the following items are present. Should there be any missing or damaged during transit contact your Clarke dealer immediately.

- 1 x Inverter Generator
- 1 x Spark Plug Box Spanner
- 1 x Screwdriver/Tommy Bar
- 1 x Container with Spout for Oil Filling
- 1 x Operating & Instruction Manual
- 1 x 12V Battery Connector Lead
- 1 x Oil Drain Tube

BEFORE USING THE GENERATOR

IMPORTANT: Generators should ALWAYS be earthed. Make sure you ground (earth) the generator.

Before using your generator check that:

- The generator is in good condition and free from any damage.
- The generator is clean and free from fuel or oil spillage.
- The generator is correctly located for use (See page 4).
- There is no leakage.

NOTE: To avoid accidental spillage of fuel, always use a funnel to fill the fuel tank. If fuel is spilled it must be removed from the unit before attempting to start the engine.

EARTH POINT

Always connect the generator to an earth point. The earth terminal is shown on the right.

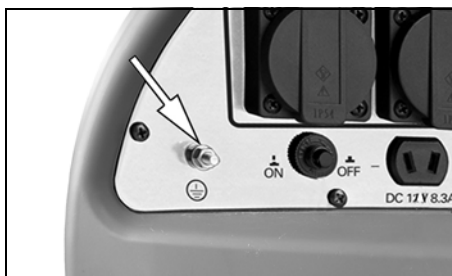

CHECKING THE AIR FILTER

1. Remove the left side maintenance panel.
2. Remove the three air filter cover screws shown on the right.



3. Slide out the air filter cover.

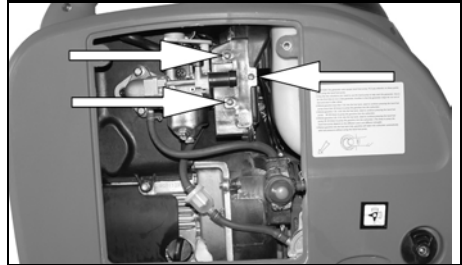

4. Remove the air filter element.
5. If the air filter is damaged contact Clarke spare parts department for a replacement.

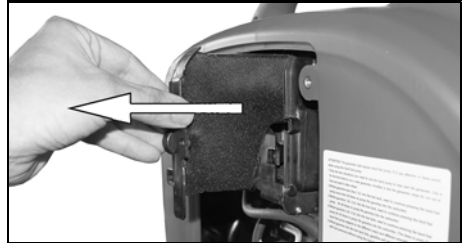

- If the filter is dirty, wash it in a solution of warm water and mild detergent and rinse thoroughly. Leave the filter to dry completely, once it is dry immerse the filter in clean engine oil and squeeze the filter to remove excess oil.

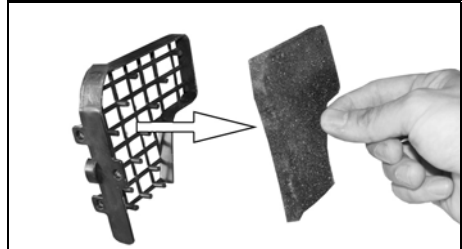

WARNING: DO NOT USE FLAMMABLE SOLVENTS OR PETROL TO CLEAN THE AIR FILTER.

6. Replace the filter into its original position and replace and secure the air filter cover then Replace the left side maintenance panel.

CHECK THE ENGINE OIL LEVEL



WARNING: YOUR GENERATOR MAY NOT BE SUPPLIED WITH OIL, ALWAYS ENSURE THAT THERE IS SUFFICIENT OIL BEFORE USE.

WARNING: TO CARRY OUT THIS CHECK, THE ENGINE MUST BE OFF.

NOTE: Place the generator on a level surface and check the oil level as follows.

1. Remove the maintenance panel shown on the right.
2. Turn the oil filler cap anti-clockwise and remove from the oil reservoir, wipe the dipstick with a clean cloth.
3. Insert the dipstick back into the oil filler tube and then remove it again.
4. If the oil is below the Min. level on the dipstick, Fill the oil reservoir with fresh oil.
 - Do not fill above the max level mark (0.45 litres)
 - We recommend the use of SAE30 oil in this generator.
 - Do not tilt the generator when adding engine oil. This could result in overfilling and damage to the engine.
5. Replace the oil filler cap.
6. Replace the left side maintenance panel.

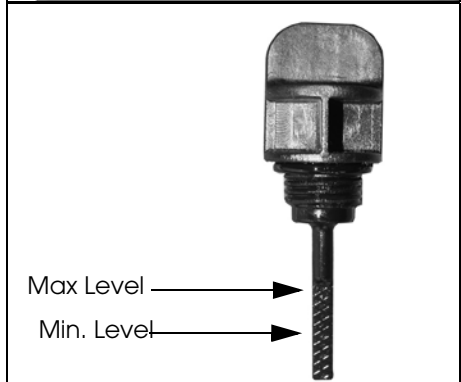
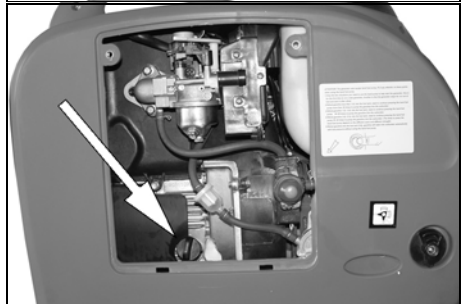

CHECK THE FUEL LEVEL



WARNING: MAKE SURE THERE IS FUEL IN THE TANK WHEN USING THE GENERATOR. RUNNING OUT OF FUEL OR STOPPING THE ENGINE SUDDENLY WITH A LOAD CONNECTED COULD CAUSE SERIOUS DAMAGE.

1. To check the fuel level, open the fuel filler cap.
2. Slowly add fuel to the fuel tank (maximum 7L)
 - Do not overfill the fuel tank.
3. Replace the fuel filler cap securely.



WARNING: FUEL IS HIGHLY FLAMMABLE AND POISONOUS.

WARNING: SEE “GENERAL SAFETY RULES” ON PAGE 4 AND READ THEM CAREFULLY BEFORE REFUELING.

WARNING: DO NOT FILL ABOVE THE TOP OF THE FUEL FILTER OR IT MAY OVERFLOW WHEN THE FUEL HEATS UP AND EXPANDS.

WARNING: WIPE UP ANY SPILLED FUEL IMMEDIATELY.

WARNING: AFTER REFUELING, MAKE SURE THE FUEL FILLER CAP IS TIGHTENED SECURELY.

RECOMMENDED FUEL

Your generator has been designed to use regular unleaded petrol with a octane number of 86 or higher.

USING YOUR GENERATOR

STARTING THE ENGINE

1. Remove all connections from the AC sockets.
2. Hold the fuel tank cap so that it will not move, and turn the air vent knob to the ON position.

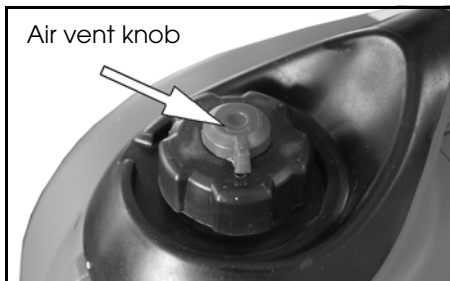

3. Turn fuel valve to the ON position (pointing downwards).



4. Set the engine switch to 'ON'.

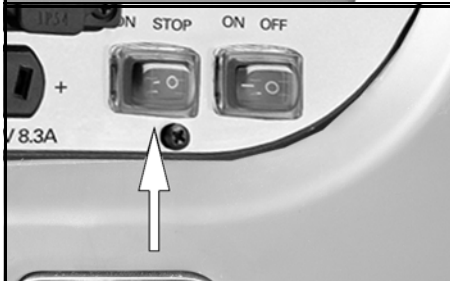

5. Set the choke to the required position.
 - If the engine is cold, move the choke to the left.
 - If the generator is warm, move the choke to the right.



6. If this is the first time you are using the generator or if the generator had run out of fuel the last time you used it, pump the primer bulb 10 times to introduce fuel into the carburettor.



7. Hold the generator handle firmly and pull the starting handle lightly until you start to feel resistance and then pull up sharply to start the engine.

NOTE: You may have to do this more than once.



WARNING: ONCE THE GENERATOR HAS STARTED, RELEASE THE STARTING HANDLE SLOWLY TO AVOID INJURY/DAMAGE AS IT WHIPS BACK.

NOTE: When you first start the generator, the overload indicator may light up for a few seconds, this is normal. If the overload indicator is still lit after 5 seconds, stop the engine and contact your Clarke dealer.

8. Once the engine has warmed up, move the choke to the right.



CONNECTING ELECTRICAL DEVICES

The generator can supply both 230V AC and 12V DC

AC POWER

1. Start the engine. See page 12.
2. Make sure the appliance is turned off before connecting it to the generator.
3. Connect the appliance to the generator.



CAUTION: MAKE SURE THAT THE APPLIANCE BEING CONNECTED IS IN GOOD WORKING ORDER, IF IT BEGINS TO ACT ABNORMALLY OR STOPS SUDDENLY, DISCONNECT IT FROM THE GENERATOR

CAUTION: MAKE SURE THE APPLIANCE DOES NOT EXCEED THE MAXIMUM RATED LOAD FOR THE GENERATOR.

CAUTION: ANY DEVICE WHICH CONTAINS AN INDUCTIVE LOAD E.G. DEVICES THAT CONTAIN A MOTOR MAY REQUIRE MORE CURRENT ON STARTUP.

DC POWER (FOR CHARGING CAR BATTERIES ONLY)



WARNING: FOR YOUR SAFETY PERFORM THE FOLLOWING INSTRUCTIONS IN THE ORDER SHOWN.

1. Set the economy control switch to 'OFF'.
2. Start the generator. See page 12.

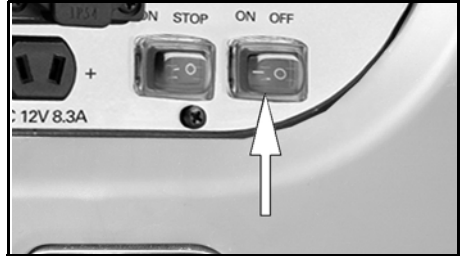

3. Connect the battery charging leads to the battery.
 - Make sure you clamp the red wire to the positive (+) terminal and the black wire to the negative (-) terminal of the battery.

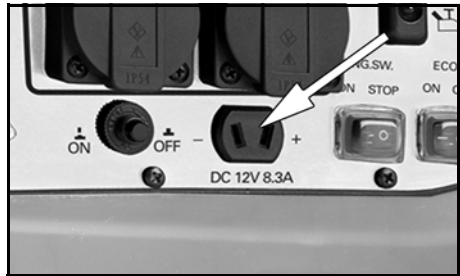

4. Connect the battery charging leads to the generator.
 - The battery will begin to charge.
5. Monitor the voltage across the battery regularly during charging and disconnect the battery when the voltage reaches 14.4 volts.



CAUTION: WHEN DISCONNECTING THE BATTERY, ALWAYS DISCONNECT THE NEGATIVE LEAD FIRST.

DC OVER LOAD PROTECTOR

If the DC overload protector activates, wait for a few minutes and then press the reset button shown on the right.

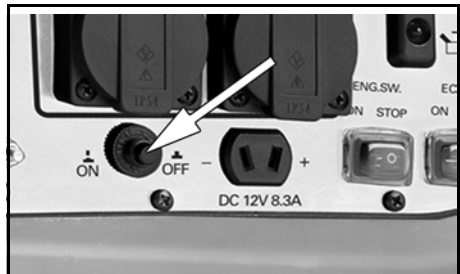

ECONOMY SWITCH

When the economy control switch is turned on, the engine speed varies according to the load connected. This results in decreased fuel consumption and less noise.

When the economy control switch is turned off, the engine runs at the 5,000 r/min. regardless of whether there is a load connected or not.

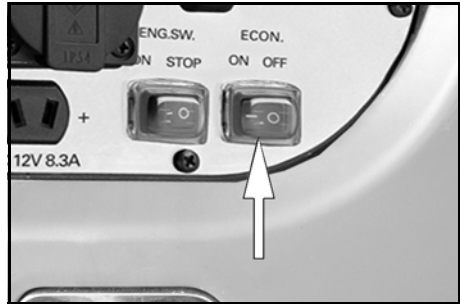

CAUTION: THE ECONOMY CONTROL DOES NOT WORK EFFECTIVELY IF THE ELECTRICAL APPLIANCE REQUIRES 'BURSTS' OF POWER.

CAUTION: TURN THE ECONOMY CONTROL FEATURE OFF WHEN CONNECTING HIGH LOAD APPLIANCES OR WHEN CONNECTING TO THE DC OUTPUT.

INDICATOR LIGHTS

PILOT LIGHT

The pilot light (Green) will remain on during normal operation.

OVERLOAD INDICATOR

The overload indicator (Red) will light up if there is an overload or a short circuit in the connected appliance.

If this happens, proceed as follows:

1. Turn off any connected electrical devices and stop the engine.
2. Reduce the total wattage of connected electric devices to within the rated output of the generator.
3. Check air inlet and around the control unit. If any blockages are found, remove them.
4. After checking, restart the engine.

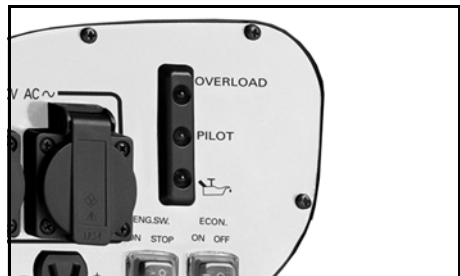

LOW OIL INDICATOR

The oil indicator will light up when the oil level is low. To add oil, follow the instructions on page 10

SHUTTING DOWN THE GENERATOR

To stop the generator in an emergency simply set the engine switch to 'OFF'.

NOTE: Turn off any electric devices.

NOTE: Set the economy control switch to the '0' (OFF) position.

1. Disconnect any electric devices.
2. Turn the fuel valve knob to "OFF" (pointing left).



3. Turn the air vent knob to the off position.

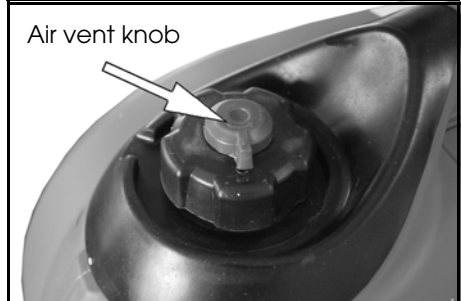

4. Set the engine switch to the "0" (OFF) position.

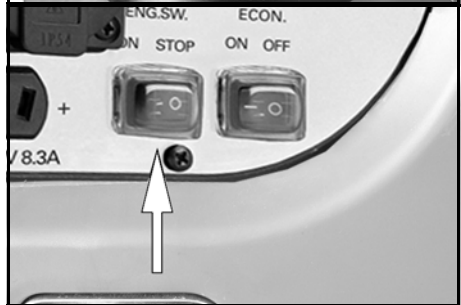

MAINTENANCE

ENGINE OIL (EVERY 20 HOURS OF USE)



CAUTION: PROLONGED EXPOSURE TO USED ENGINE OIL IS DANGEROUS, ALWAYS WASH YOUR HANDS THOROUGHLY AFTER HANDLING USED ENGINE OIL.

1. Remove the maintenance panel shown on the right.



2. Turn the oil filler cap anti-clockwise and remove from the oil tank.

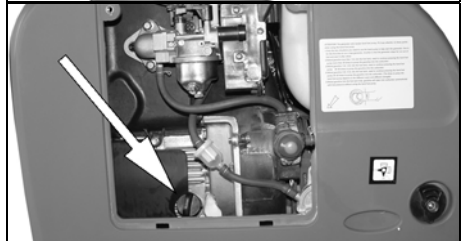

3. Screw the oil drain tube into the oil tank as shown.
4. Tilt the generator to allow the oil to drain out of the oil reservoir into a suitable container.



NOTE: You may need assistance with this step as the generator is heavy.

5. Fill the oil reservoir with fresh oil.
 - Do not fill above the max level mark (0.45 litres)
 - We recommend the use of SAE30 oil in this generator.
6. Replace the oil filler cap and maintenance panel.

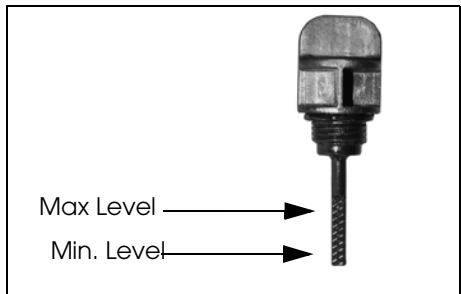

AIR FILTER (EVERY 50 HOURS OF USE)

1. Remove the maintenance panel shown on the right.



2. Remove the three air filter cover screws .

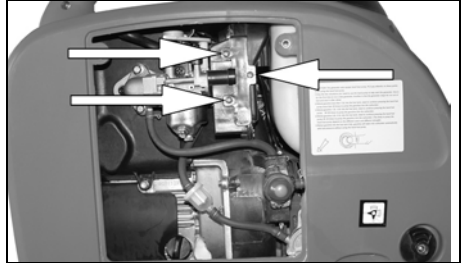

3. Pull out the air filter cover.



4. Remove the air filter element.

5. If the air filter is damaged contact Clarke spare parts department for a replacement.

- If the filter is dirty, wash it in a solution of warm water and mild detergent and then rinse thoroughly.
- Leave the filter to dry completely, once it is dry immerse the filter in clean engine oil and squeeze the filter to remove excess oil.

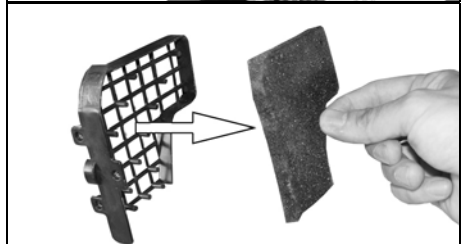

WARNING: DO NOT USE FLAMMABLE SOLVENTS OR PETROL TO CLEAN THE AIR FILTER.

6. Replace the filter into its original position and replace and secure the air filter cover.

SPARK PLUG (EVERY 50 HOURS OF USE)



CAUTION: ALLOW THE ENGINE TO COOL BEFORE REMOVING THE SPARK PLUG.

1. Remove the top maintenance panel.
2. Remove the spark plug cap from the spark plug.
3. Assemble the spark plug spanner as shown.



4. Use the spark plug spanner (supplied) to remove the spark plug.
5. Check for discoloration and use a wire brush to remove any carbon build up.



6. Check the spark plug gap (a) with a feeler guage, it should be between 0.6 and 0.7 mm.

- Adjust if necessary.

7. Check the overall condition of the spark plug and replace if damaged.

NOTE: Spark plugs are available from Clarke Spare Parts department 020 8988 7400.

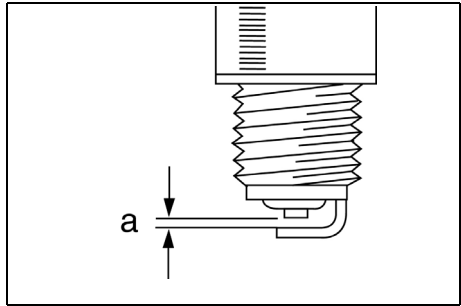

8. Reinstall the spark plug and replace the spark plug cap.

FUEL TANK FILTER

Just inside the fuel tank is a fuel filter, check this filter periodically and remove any contaminants which may have accumulated.

1. Remove the fuel tank cap
2. Lift out the filter inside.



3. Clean the filter with solvent. If damaged, replace.
4. Relace the filter and fuel tank cap.

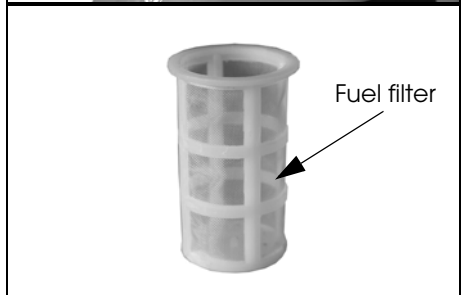

TROUBLESHOOTING

| | CAUSE | SOLUTION |
|---|---|---|
| The generator fails to start | Engine switch is off | Set the engine switch to 'on' |
| | Not enough oil in the generator | Add more oil, See page 10 |
| | No fuel | Add more fuel, See page 11 |
| | Spark plug not working correctly | Change the spark plug. See page 20 |
| The generator fails to generate electricity | The device you are trying to power is faulty | Make sure the device you want to power is working properly |
| | The overload indicator is on | Remove the appliance immediately, do not connect any appliance that requires more than 2.2 KVA. |
| | (DC supply only) The DC Overload protector has activated. | Press the reset button. See page 16 |
| The generator is difficult to start | The air filter is dirty | Clean the air filter. See page 19 |

If this does not solve your problem, please contact the Clarke service department. see below.

PARTS AND SERVICING

For Parts & Servicing, please contact your nearest dealer, or CLARKE International, on one of the following numbers.

PARTS & SERVICE TEL: 020 8988 7400
PARTS & SERVICE FAX: 020 8558 3622
or e-mail as follows:
PARTS: Parts@clarkeinternational.com
SERVICE: Service@clarkeinternational.com

SPECIFICATIONS

| | | IG2200 |
|------------|----------------------------------|---|
| Engine | Engine Model | 152F |
| | Type | Forced air cooled 4-stroke gasoline OHV |
| | Displacement (cm ³) | 125 |
| | Ignition type | T.D.I |
| | Fuel tank capacity (L) | 7 |
| | Maximum run time at 3/4 load (h) | 7 |
| | Engine oil capacity (L) | 0.45 |
| | Guaranteed sound power (LWA dB) | 94 dB |
| Generator | Rated Frequency (Hz) | 50 |
| | Rated AC Voltage (V) | 230 |
| | Rated Power (KW) | 2 |
| | Max. Power (KW) | 2.2 |
| | Rated DC Voltage (V) | 12 |
| | Rated DC Current (A) | 8.3 |
| Dimensions | Length (mm) | 542 |
| | Width (mm) | 288 |
| | Height (mm) | 486 |
| | Unpacked Weight (kg) | 26.6 |

DECLARATION OF CONFORMITY



Clarke[®]
INTERNATIONAL

Hemnoll Street, Epping, Essex CM16 4LG

DECLARATION OF CONFORMITY

This is an important document and should be retained.

Product Description: 2000W Inverter Generator
Model number(s): IG2200
Serial / batch Number: 8877055
Date of Issue: 01/12/2009
(Noise Conformity)
Notified Body: Societe Nationale De Certification ETD'
Homologation S.A.R.L (SNCH)
11 Rout De Sandweiler
5230 Sandweiler
Luxembourg

Technical Documentation Holder: Alan Pond
Clarke International
2a Shrubland Road
London E10,7RB
UK

Conformity Assessment Procedure: to 2000/14/EC Annex VI
Manufacturer: Clarke International
Noise Related Value: 2.0 kW
Measured Sound Power Level: 89 dB
Guaranteed Sound Power Level: 94 dB

DECLARATION OF CONFORMITY



Clarke[®]
INTERNATIONAL

Hemnal Street, Epping, Essex CM16 4LG

DECLARATION OF CONFORMITY

This is an important document and should be retained.

We hereby declare that this product(s) complies with the following directive(s):

- 2004/108/EC *Electromagnetic Compatibility Directive.*
- 2006/42/EC *Machinery Directive.*
- 2006/95/EEC *Low Voltage Equipment Directive.*
- 2000/14/EC *Noise Emissions Directive, (amended by 2005/88/EC).*
- 97/68/EC *Emission of Gaseous Particulates, (amended by 2002/88/EC).*

The following standards have been applied to the product(s):

EN 55012:2002+A1, EN 61000-6-1:2001, EN 61000-6-3: 2001 +A11, EN 3744:1995, EN 12601:2001, EN 60034-22:1997.

The technical documentation required to demonstrate that the product(s) meet(s) the requirement(s) of the aforementioned directive(s) has been compiled and is available for inspection by the relevant enforcement authorities.

The CE mark was first applied in: 2006

Signed:

J.A. Clarke
Managing Director

A SELECTION FROM THE VAST RANGE OF

Clarke®

QUALITY PRODUCTS

AIR COMPRESSORS

From DIY to industrial, Plus air tools, spray guns and accessories.

GENERATORS

Prime duty or emergency standby for business, home and leisure.

POWER WASHERS

Hot and cold, electric and engine driven - we have what you need

WELDERS

Mig, Arc, Tig and Spot. From DIY to auto/industrial.

METALWORKING

Drills, grinders and saws for DIY and professional use.

WOODWORKING

Saws, sanders, lathes, mortisers and dust extraction.

HYDRAULICS

Cranes, body repair kits, transmission jacks for all types of workshop use.

WATER PUMPS

Submersible, electric and engine driven for DIY, agriculture and industry.

POWER TOOLS

Angle grinders, cordless drill sets, saws and sanders..

STARTERS/CHARGERS

All sizes for car and commercial use.

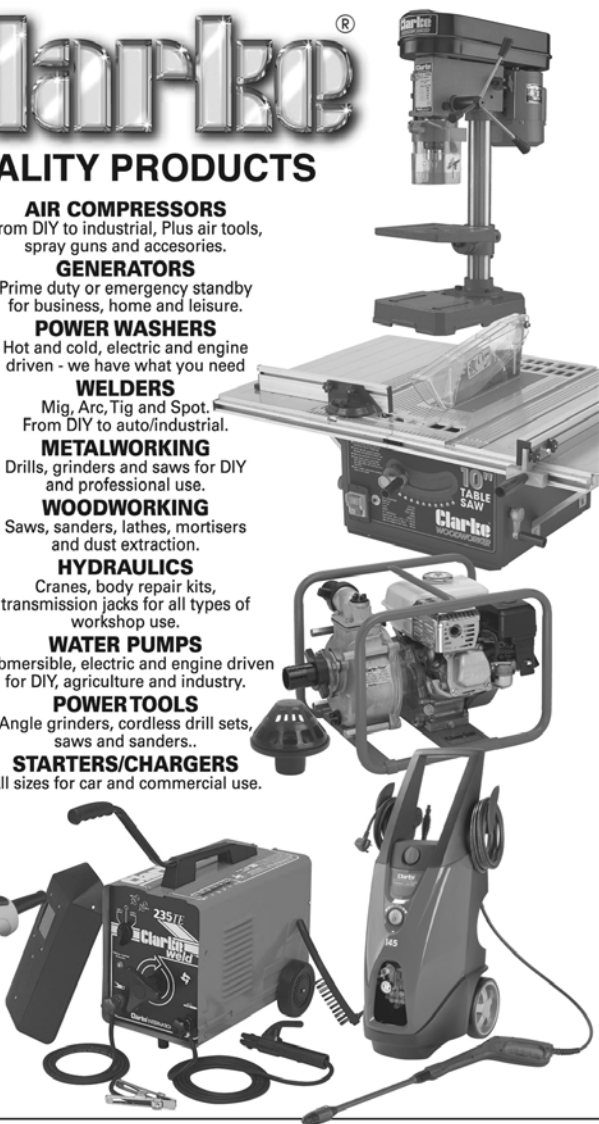

PARTS & SERVICE: 0208 988 7400

E-mail: Parts@clarkeinternational.com or Service@clarkeinternational.com

SALES: UK 01992 565333 or Export 00 44 (0)1992 565335

Clarke INTERNATIONAL Hemnall Street, Epping, Essex CM16 4LG
www.clarkeinternational.com